

**STAYING
HEALTHY
SIGNAGE**



healthy@dgi-invisualse.com

The DGI Difference

Print and design is what we do.

DGI has over 25 years of experience producing signage and decals for top retailers and fortune 500 companies. We are a 3M Authorized Scotchprint manufacturer and a G7 Certified Master Color printer. Our R&D team carefully chooses our materials and tests them in the field to be sure they meet our client's expectations. Our creative designers will customize any signage with your corporate colors, logo or offer a custom design and our sales team will offer cost effective sizing and quantity price breaks for your project.

Email us to experience the DGI Difference. healthy@dgicommunications.com



DECALS AND SIGNS



\$2.50

SHS-DS-1A
STAY SAFE
Size: 8" x 8" QTY



\$2.50

SHS-DS-1B
FACE MASK
Size: 8" x 8" QTY



\$2.50

SHS-DS-1C
KEEP SAFE
Size: 8" x 8" QTY



\$3.00

SHS-DS-1I
DOOR TAG
Size: 3.75" x 8.75" QTY



\$2.50

SHS-DS-1D
PLEASE WAIT
Size: 8" x 8" QTY



\$2.50

SHS-DS-1E
WASH HANDS
Size: 8" x 8" QTY



\$2.50

SHS-DS-1F
SANITIZE
Size: 8" x 8" QTY



\$2.50

SHS-DS-1G
CHECK YOUR TEMP
Size: 8" x 8" QTY



\$2.50

SHS-DS-1H
SCAN QR
Size: 8" x 8" QTY



CUSTOM SIZES AVAILABLE



TABLE TENT CARDS

FOLD UNDER

Make sure to wipe down all surfaces when finished



Make sure to wipe down all surfaces when finished



FOLD UNDER

\$4.00

SHS-TT-2A
WIPE SURFACE
Size: 5" x 19" QTY

FOLD UNDER

PLEASE PRACTICE SOCIAL DISTANCING

PLEASE PRACTICE SOCIAL DISTANCING



FOLD UNDER

\$4.00

SHS-TT-2B
SOCIAL DISTANCE
Size: 5" x 19" QTY

FOLD UNDER

Please wash hands for 20 seconds with soap and water

Please wash hands for 20 seconds with soap and water



FOLD UNDER

\$4.00

SHS-TT-2C
WASH HANDS
Size: 5" x 19" QTY

FOLD UNDER

PLEASE WEAR A FACE MASK

PLEASE WEAR A FACE MASK

FOLD UNDER

\$4.00

SHS-TT-2D
WEAR MASK
Size: 5" x 19" QTY

FOLD UNDER



SCAN HERE TO RESERVE A ROOM

SCAN HERE TO RESERVE A ROOM



FOLD UNDER

\$4.00

SHS-TT-2E
QR CODE
Size: 5" x 19" QTY



WELCOME BACK!

WEAR A MASK IN PUBLIC AREAS

WASH/SANITIZE HANDS OFTEN

KEEP SAFE DISTANCE

KEEP WORK AREAS CLEAN

STAY HOME IF YOU ARE SICK

\$215.00
Stand Included



SHS-RBS-3A
WELCOME BACK
Size: 31.5" x 89.5"

 QTY

REMEMBER 6 FEET APART SOCIAL DISTANCING

SAFETY TIPS & PREVENTION

- Wash Hands Thoroughly
- Avoid Large Crowds
- Use Soap or Hand Sanitizer
- Do Not Touch Your Face esp. Mouth, Eyes, Nose
- Keep Safe Distance from Other People (min 6')
- Do Not Meet Infected or Sick People
- Use Face Mask
- Do Not Touch The Front Part of a Mask
- Stay at Home if Possible
- Do Not Travel Unless Necessary

REMEMBER 6 FEET APART SOCIAL DISTANCING

\$70.00

SHS-FNG-3B
SAFETY TIPS
Size: 56" x 72"

 QTY

FLOOR GRAPHICS

Considerations should be made for floor graphics and the surface they will be applied to. We offer several options including an all in one vinyl that works on smooth indoor floors or low pile carpet, this is the best option when you don't know what surface you are applying to. We also have floor decals for very specific surfaces as well as an outdoor option. Communicating with our Sales Team on where your floor decals will be applied is important to ensure the best material is used for your application.

Types of Floors

Indoor Smooth Floor: Linoleum, vinyl, tile, wood, indoor sealed concrete, marble. When possible recommend floor is stripped to remove wax, install graphics, reapply wax on top of graphics.

Low Pile Carpet: Carpet needs to be firmly attached, level low piles. The carpet must be clean and completely dry. No recent steam cleaning, and once installed steam cleaning not advised, and avoid vacuuming over edges as lifting may occur.

Exterior Placement: Concrete and asphalt. Surface must be clean, dry and free of debris or residues.

HINTS: When designing your floor decals stay away from sharp corners & angles as corners and sharp angles will tend to lift. Avoid intricate cutting patterns, rounded corners, circle shapes are most successful. Our Floor Decals are easily removable up to 3 months, adhesion may increase over time.



FLOOR AND WALL DECALS



\$22.00

SHS-FWD-4A
SAFE DISTANCE
Size: 30" x 16"

 QTY

\$12.00

SHS-FWD-4B
PLEASE WAIT
Size: 24" x 12"

 QTY

\$15.00

SHS-FWD-4C
FEET
Size: 17" x 19.5"

 QTY

\$7.00

SHS-FWD-4D
WEAR A MASK
Size: 12" x 12"

 QTY



\$7.00

SHS-FWD-4E
KEEP SAFE
Size: 12" x 12"

 QTY

\$7.00

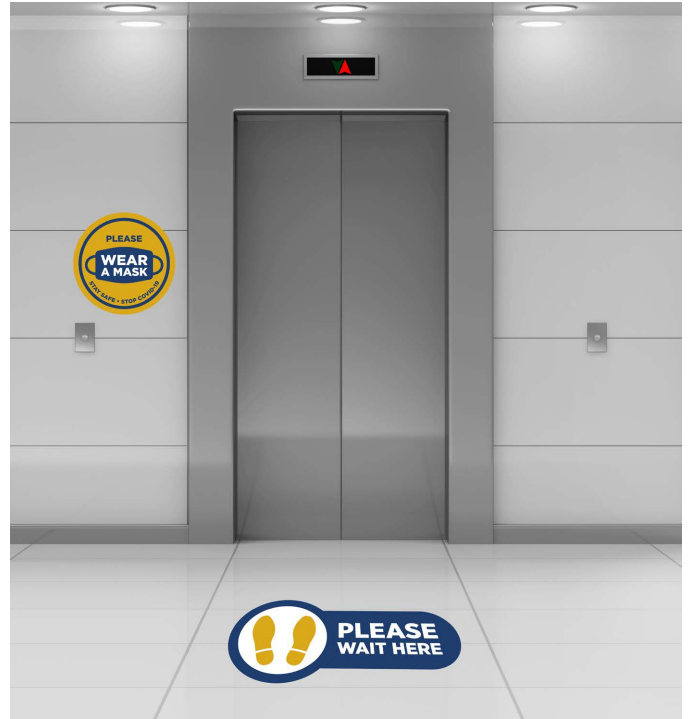
SHS-FWD-4F
ARROW UP
Size: 12" x 12"

 QTY

\$8.00

SHS-FWD-4G
ARROW LEFT
Size: 22" x 7.5"

 QTY

\$8.00

SHS-FWD-4H
ARROW RIGHT
Size: 22" x 7.5"

 QTY

CUSTOM SIZES AVAILABLE



SMOOTH SURFACE DECALS



\$2.50

SHS-SSD-5A
MAXIMUM OCCUPANCY
Size: 8" x 8" QTY



\$3.50

SHS-SSD-5B
HAND SANITIZER
Size: 8" x 11" QTY



\$1.50

SHS-SSD-5C
DO NOT SIT
Size: 7" x 3" QTY



\$1.50

SHS-SSD-5D
SIT HERE
Size: 7" x 3" QTY



\$2.00

SHS-SSD-5E
WASH YOUR HANDS
Size: 6" x 6" QTY



\$6.50

SHS-SSD-5F
ROOM CLOSED
Size: 12" x 12" QTY



\$2.00

SHS-SSD-5G
SHARED SPACE
Size: 6" x 6" QTY



CUSTOM SIZES AVAILABLE



OUTDOOR GRAPHICS

**A-FRAME SIGNS ARE DOUBLE SIDED
FOR EVERY A-FRAME ORDERED TO THE RIGHT
YOU MUST SELECT 2 GRAPHICS BELOW**



SHS-OG-6A-AF
PHYSICAL DISTANCE
Size: 24" x 36"

 QTY

SHS-OG-6B-AF
TEMP CHECK
Size: 24" x 36"

 QTY

SHS-OG-6C-AF
REMEMBER MASK
Size: 24" x 36"

 QTY

SHS-OG-6D-AF
WELCOME BACK
Size: 24" x 36"

 QTY

ENTER A-FRAME
QTY

**WINDMASTER SIGNS ARE DOUBLE SIDED
FOR EVERY WINDMASTER ORDERED TO THE RIGHT
YOU MUST SELECT 2 GRAPHICS BELOW**

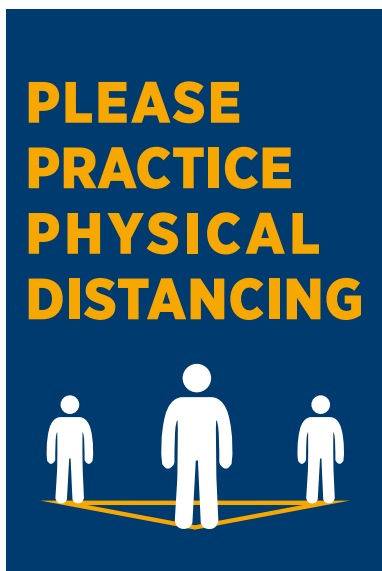

SHS-OG-6A-WM
PHYSICAL DISTANCE
Size: 23.375"x33.125"

 QTY

SHS-OG-6B-WM
TEMP CHECK
Size: 23.375"x33.125"

 QTY

SHS-OG-6C-WM
REMEMBER MASK
Size: 23.375"x33.125"

 QTY

SHS-OG-6D-WM
WELCOME BACK
Size: 23.375"x33.125"

 QTY

ENTER WINDMASTER
QTY



ACRYLIC PROTECTIVE BARRIERS

Acrylic barriers and dividers offer added protection in various environments from offices to retail spaces. DGI offers Free Standing and Hardware Secured solutions each with several varieties of lengths and heights.



WORKSTATION DIVIDERS

UN BRANDED

\$200.00 SHS-WD-7A-UB
Safety Shield w/Feet - 47in
Size: 47"x31"
QTY

\$190.00 SHS-WD-7B-UB
Safety Shield w/Feet - 32in
Size: 32"x31"
QTY

\$120.00 SHS-WD-7C-UB
Safety Shield w/Feet - 23in
Size: 23"x31"
QTY

BRANDED

(4" High Logo or Message)

\$220.00 SHS-WD-7A-B
Safety Shield w/Feet - 47in
Size: 47"x31"
QTY

\$205.00 SHS-WD-7B-B
Safety Shield w/Feet - 32in
Size: 32"x31"
QTY

\$132.00 SHS-WD-7C-B
Safety Shield w/Feet - 23in
Size: 23"x31"
QTY

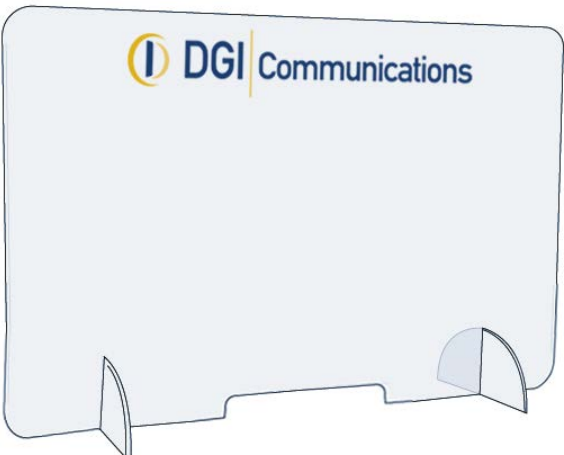
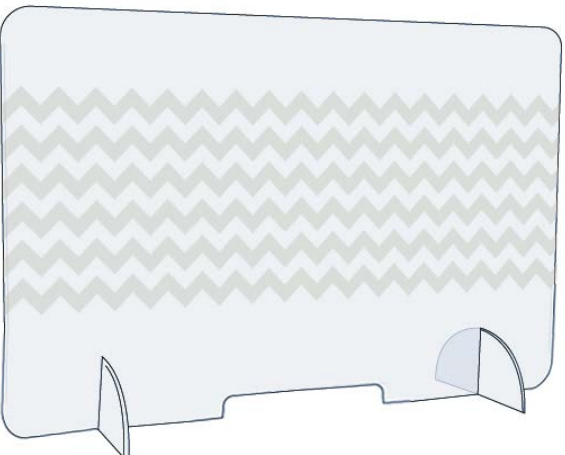
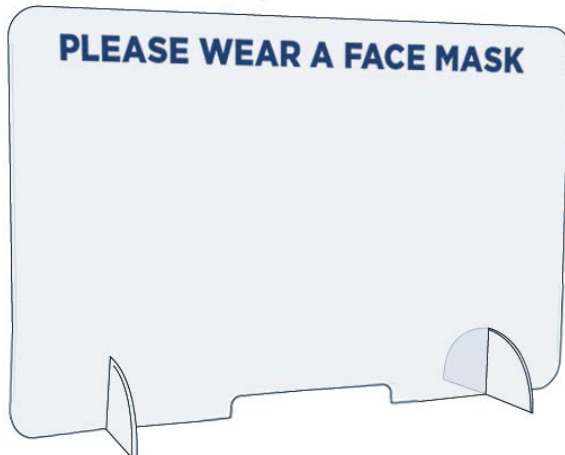
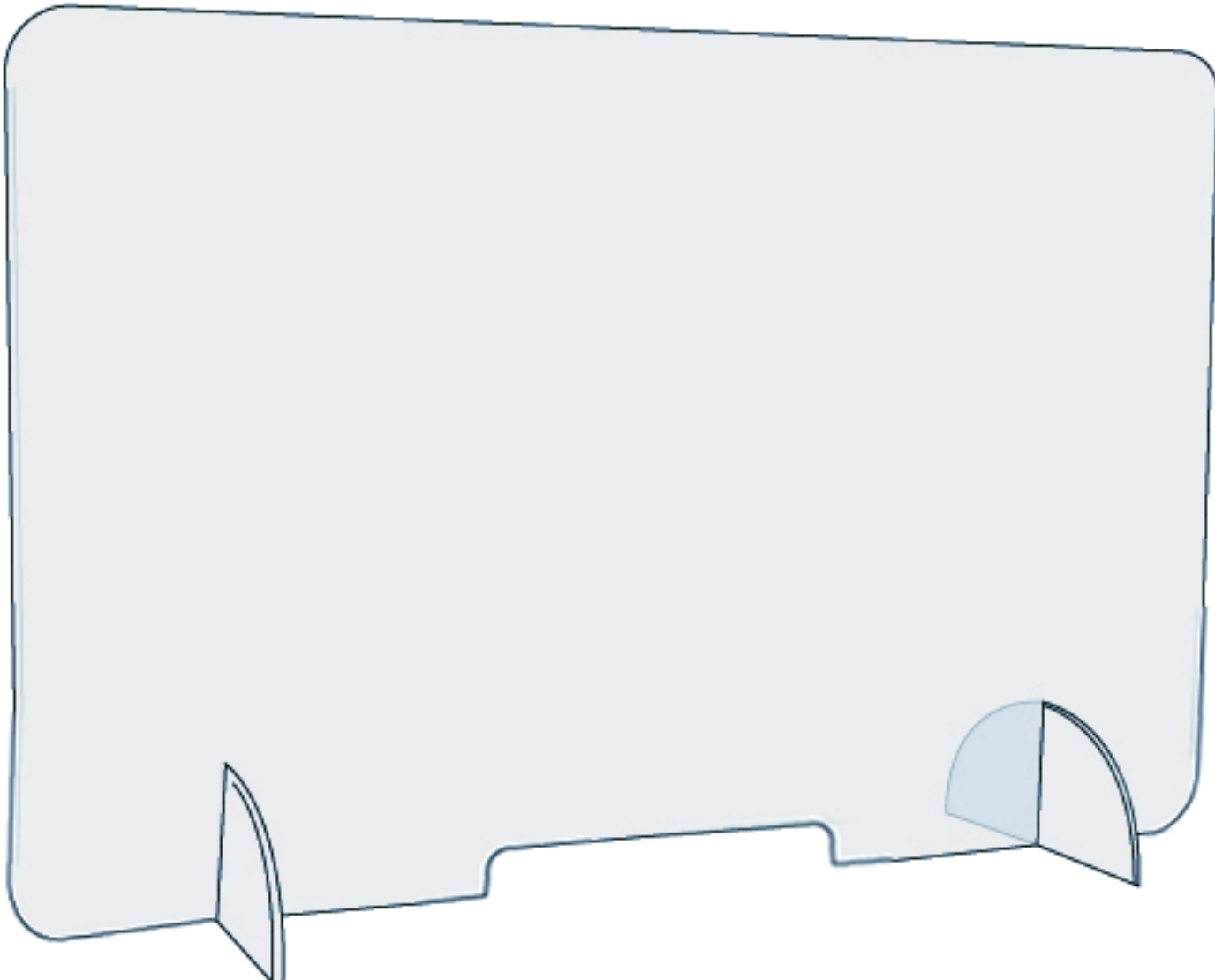

CALL FOR CUSTOM GRAPHICS ON BARRIERS



ACRYLIC BARRIERS

- DGI has a wide array of acrylic barrier offerings that will keep you and your staff safe.
- From cubicle extenders to cashier counter tops, DGI not only offers standard products, but can create a custom solution for your particular space.
- Contact DGI for pricing on custom barrier solutions

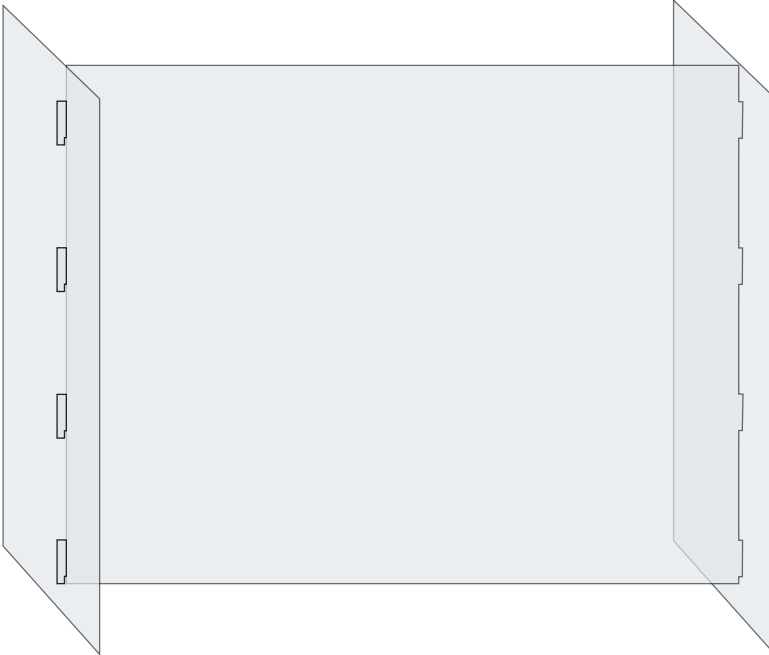
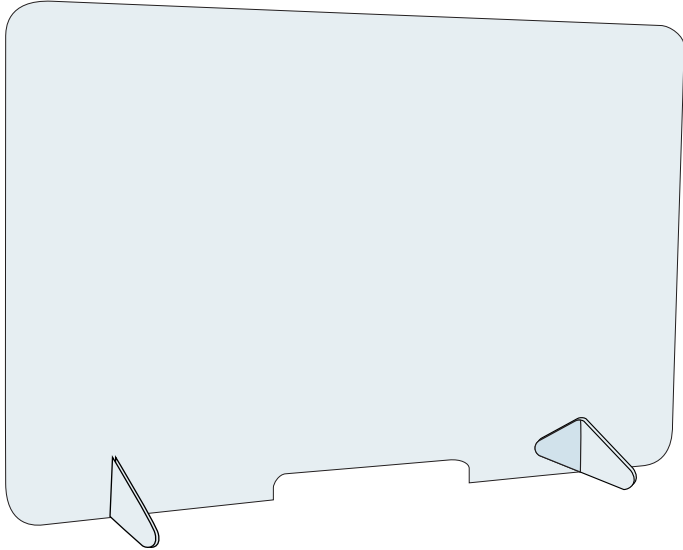
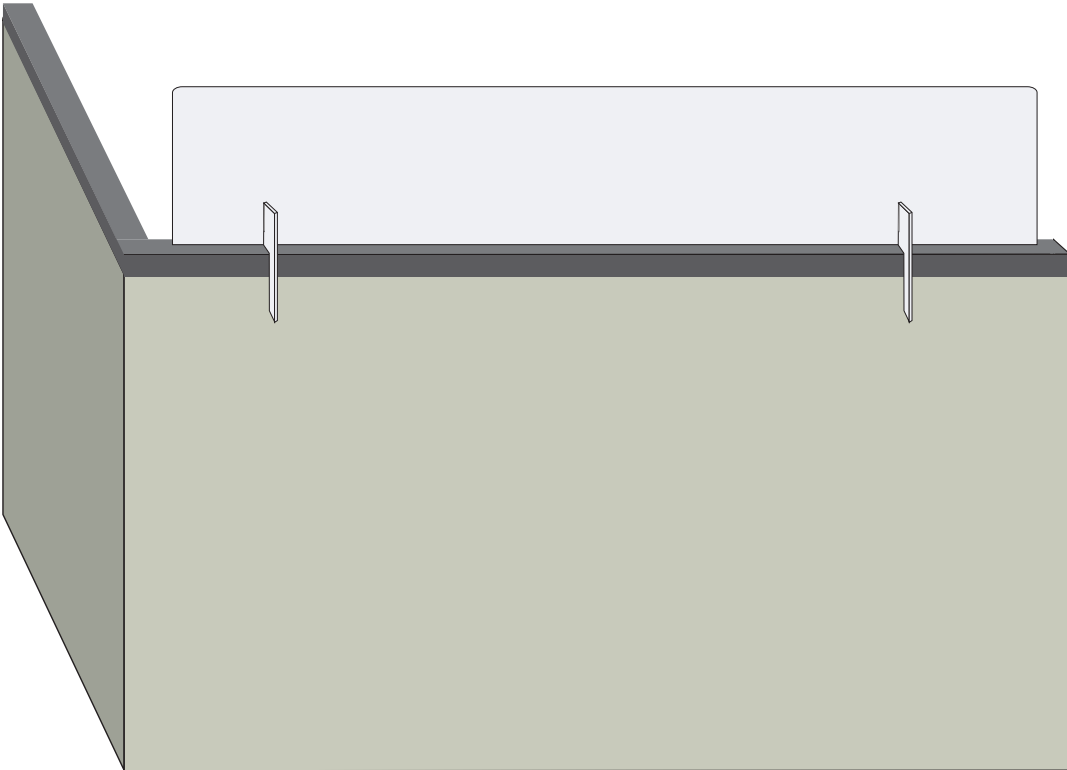
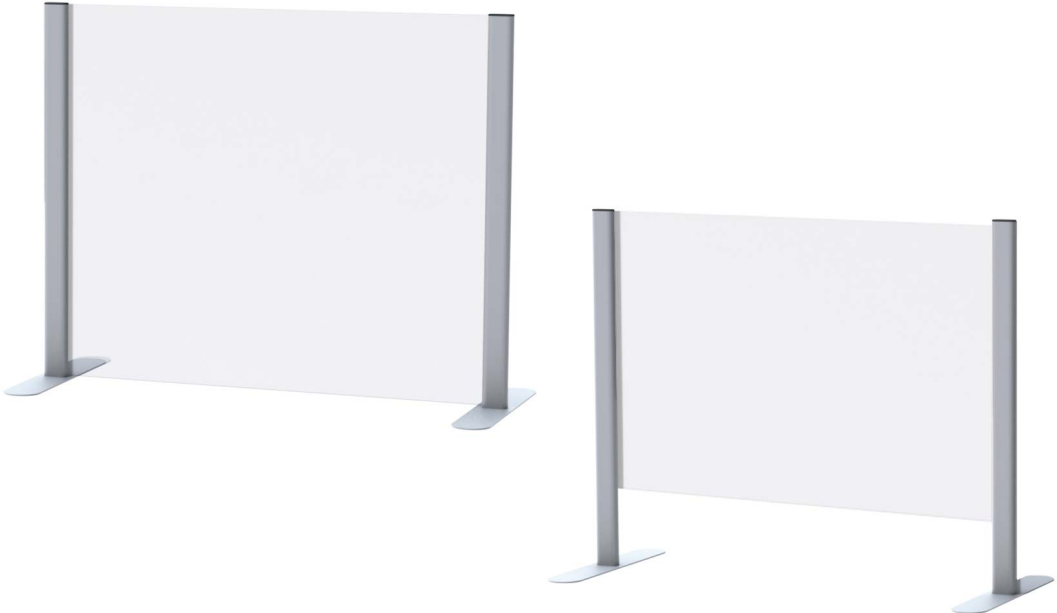

FACE SHIELDS

- Clear plastic PET face shield with elastic head band to ensure a proper fit
- Shield thickness .025"
- 9" elastic band which allows for one size fits all
- PET is a Polyester resin and it is known for their excellent combination of properties such as mechanical, thermal, chemical resistance as well as dimensional stability.
- Can be custom branded with your logo or name
- Made in the United States

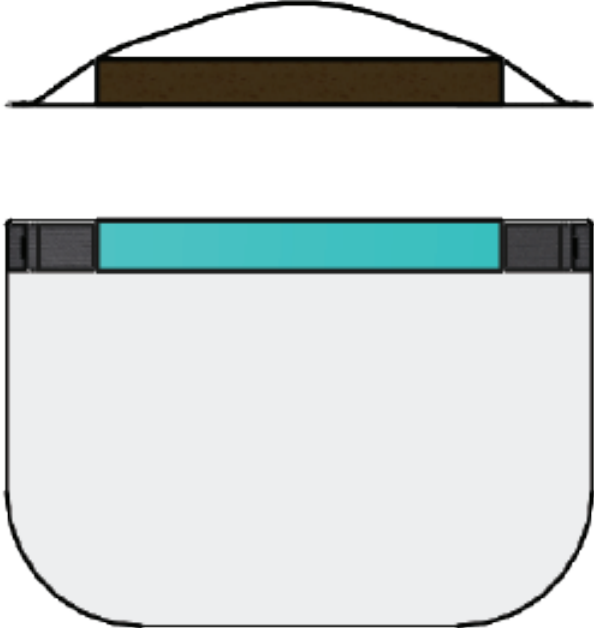
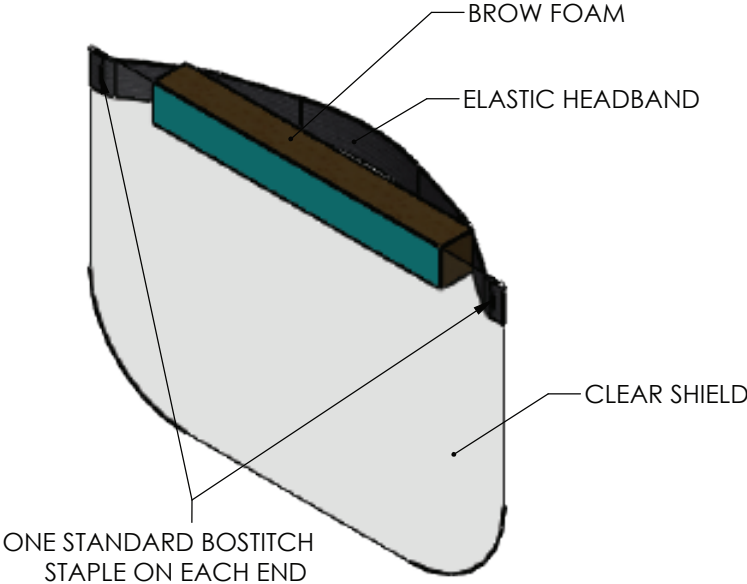

\$7.00
UNBRANDED

SHS-FS-8A-UB
Face Shield
Size: 13"x 9"

QTY

\$12.00
BRANDED

SHS-FS-8A-B
Face Shield
Size: 13"x 9"

QTY



ORDER FORM

SKU	ITEM	DESCRIPTION	QTY	PRICE	TOTAL
SHS-DS-1A		Lo Tack Adhesive Vinyl Decal			
SHS-DS-1B		Lo Tack Adhesive Vinyl Decal			
SHS-DS-1C		Lo Tack Adhesive Vinyl Decal			
SHS-DS-1D		Lo Tack Adhesive Vinyl Decal			
SHS-DS-1E		Lo Tack Adhesive Vinyl Decal			
SHS-DS-1F		Lo Tack Adhesive Vinyl Decal			
SHS-DS-1G		Lo Tack Adhesive Vinyl Decal			
SHS-DS-1H		Lo Tack Adhesive Vinyl Decal			
SHS-DS-1I		Plastic Hanging Door Tag			
SHS-TT-2A		Cardstock Table Tent Card			
SHS-TT-2B		Cardstock Table Tent Card			
SHS-TT-2C		Cardstock Table Tent Card			
SHS-TT-2D		Cardstock Table Tent Card			
SHS-TT-2E		Cardstock Table Tent Card			
SHS-RBS-3A		Banner & Bannerstand			
SHS-FNG-3B		Fold-N-Go Trifold Display			
SHS-FWD-4A		Floor & Wall Decal			
SHS-FWD-4B		Floor & Wall Decal			
SHS-FWD-4C		Floor & Wall Decal			
SHS-FWD-4D		Floor & Wall Decal			
SHS-FWD-4E		Floor & Wall Decal			
SHS-FWD-4F		Floor & Wall Decal			
SHS-FWD-4G		Floor & Wall Decal			
SHS-FWD-4H		Floor & Wall Decal			

SKU	ITEM	DESCRIPTION	QTY	PRICE	TOTAL
SHS-SSD-5A		Lo Tack Adhesive Vinyl Decal			
SHS-SSD-5B		Lo Tack Adhesive Vinyl Decal			
SHS-SSD-5C		Lo Tack Adhesive Vinyl Decal			
SHS-SSD-5D		Lo Tack Adhesive Vinyl Decal			
SHS-SSD-5E		Lo Tack Adhesive Vinyl Decal			
SHS-SSD-5F		Lo Tack Adhesive Vinyl Decal			
SHS-SSD-5G		Lo Tack Adhesive Vinyl Decal			
SHS-AFRAME		A-Frame Sign Hardware			
SHS-OG-6A-AF		Styrene Print for A-Frame			Included with stand price
SHS-OG-6B-AF		Styrene Print for A-Frame			Included with stand price
SHS-OG-6C-AF		Styrene Print for A-Frame			Included with stand price
SHS-OG-6D-AF		Styrene Print for A-Frame			Included with stand price
SHS-WMASTR		Windmaster Sign Hardware			
SHS-OG-6A-WM		Styrene Print for Windmaster			Included with stand price
SHS-OG-6B-WM		Styrene Print for Windmaster			Included with stand price
SHS-OG-6C-WM		Styrene Print for Windmaster			Included with stand price
SHS-OG-6D-WM		Styrene Print for Windmaster			Included with stand price
SHS-WD-7A-UB		Unbranded 47" Safety Shield			
SHS-WD-7B-UB		Unbranded 32" Safety Shield			
SHS-WD-7C-UB		Unbranded 23" Safety Shield			
SHS-WD-7A-B		Branded 47" Safety Shield			
SHS-WD-7B-B		Branded 32" Safety Shield			
SHS-WD-7C-B		Branded 23" Safety Shield			
SHS-FS-8A-UB		Unbranded Face Shield			
SHS-FS-8A-B		Branded Face Shield			
					Sub Total*

Ship To: (Name, Address, Phone & Email)

Bill To: (Name, Address, Phone & Email)

Check if Same

Company:		Company:	
Contact:		Contact:	
Address 1:		Address 1:	
Address 2:		Address 2:	
City, State, Zip:		City, State, Zip:	
Email:		Email:	
Comments/Notes:		Comments/Notes:	

***Please Note: The sub total does not include taxes or shipping. Taxes and shipping are calculated upon final billing. If you'd like a total including tax and shipping, please reach out to healthy@dgicommunications.com.**

When order form is complete, or if you need assistance, please contact your Sales Representative